

# MDT 218 J10

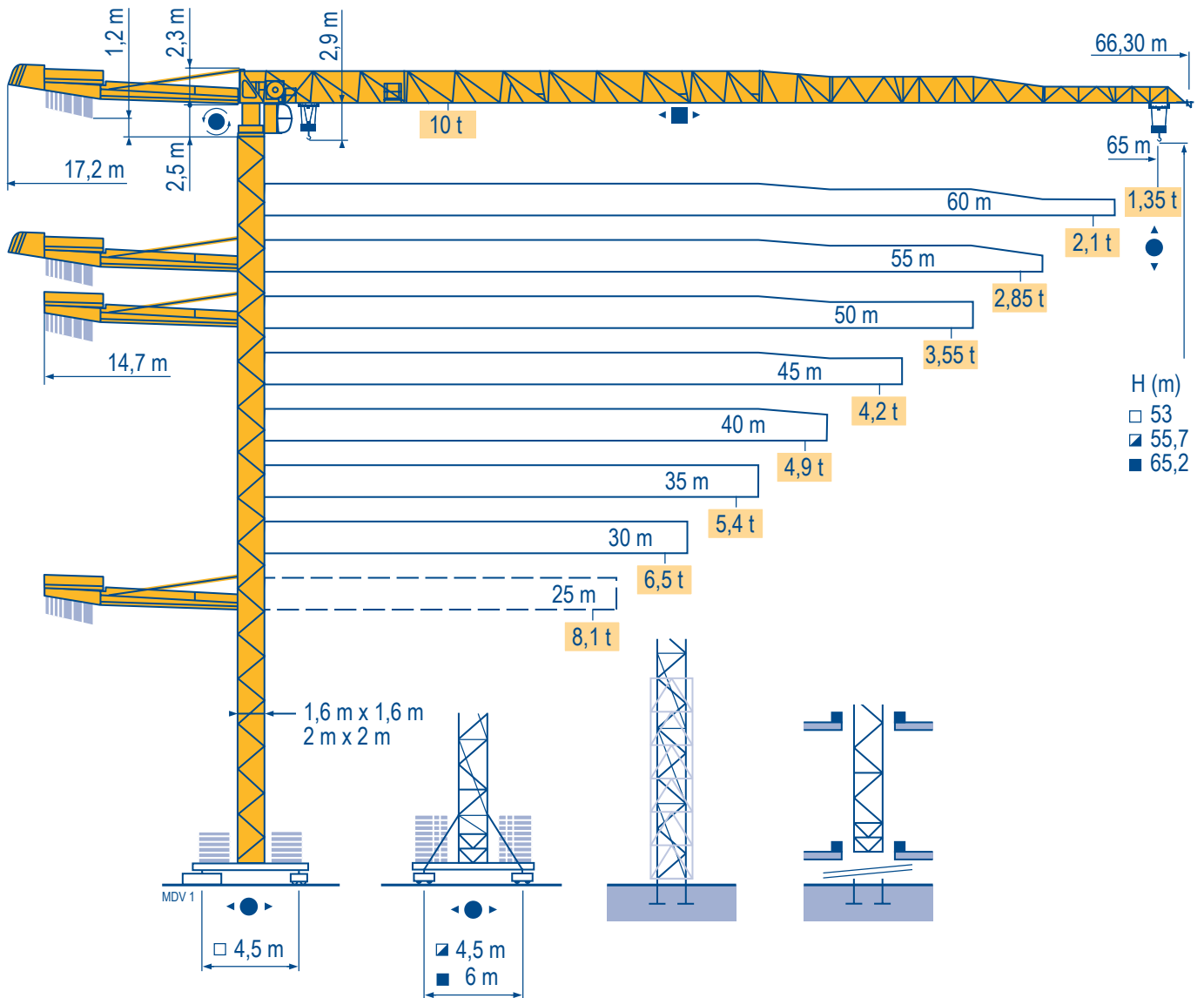

## City Topless

Mat / Réactions  $\square$  1,6 m

Maste / Eckdrücke

Masts / Reactions

Mástil / Reacciones

Torre / Reazioni

Tramo / Reações

Композиции башни / Реакции

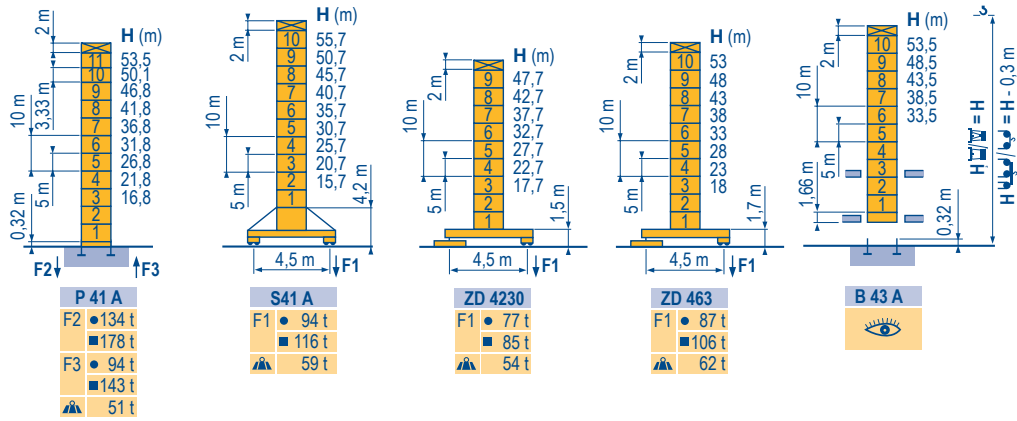

MDV 2

$\square$  2 m

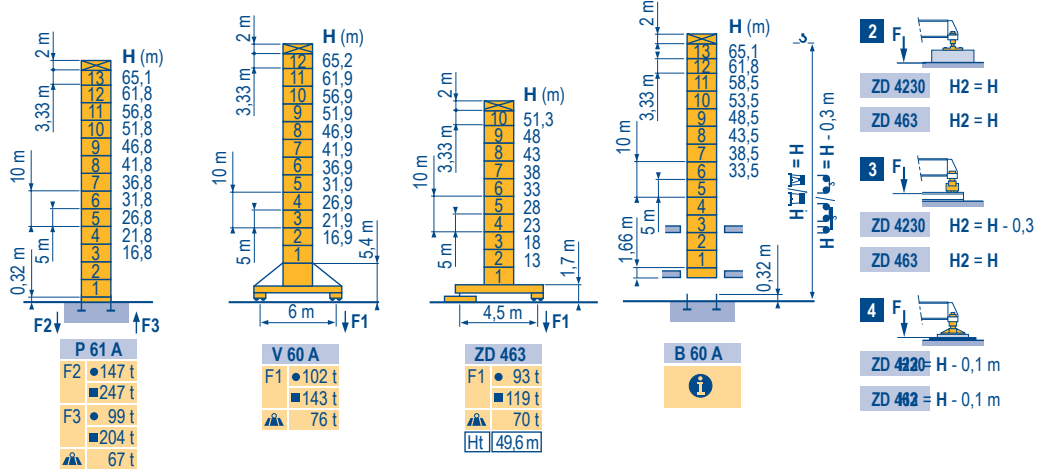

Télescopage sur dalles

Kletterkrane im Gebäude

Climbing crane

Telescopage gruas trepadoras

Gru in cavedio

Telescopagem sobre lagas

Кран, ползущий внутри здания

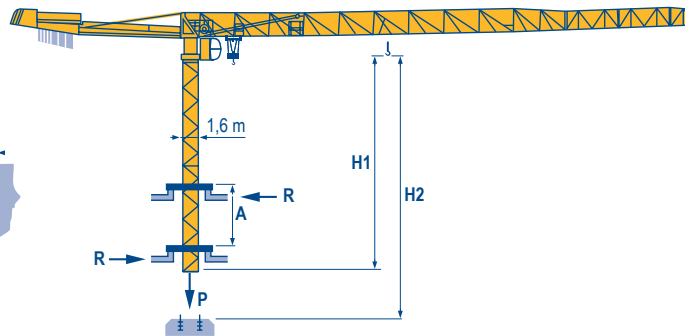
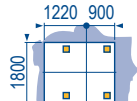

B 43 A

B 60 A

MDV 2

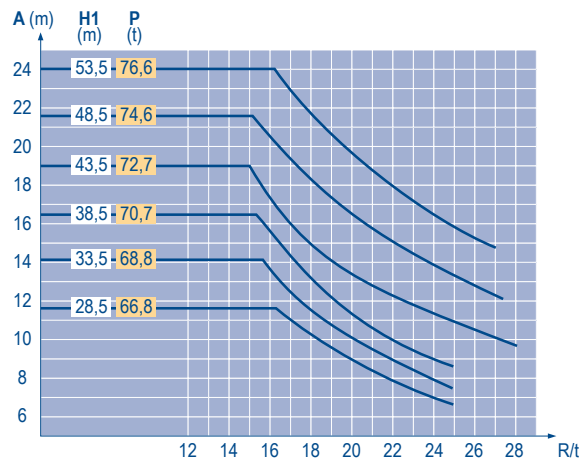

City Topless

MDT 218 J10

POTAIN

FR

Réactions en service  
Réactions hors service



A vide sans lest (ni train de transport) avec flèche et hauteur maximum.



Nous consulter  
Hauteur maxi roulante

DE

Reaktionskräfte in Betrieb  
Reaktionskräfte außer Betrieb

Ohne Last, Ballast (und Transportachse), mit Maximalausleger und Maximalhöhe.

Auf Anfrage  
Fahrbare max. Höhe

EN

Reactions in service  
Reactions out of service

Without load, ballast (or transport axes), with maximum jib and maximum height.

Consult us  
Travelling maximum height

ES

Reacciones en servicio  
Reacciones fuera de servicio

Sin carga, sin lastre, (ni tren de transporte), flecha y altura máxima.

Consultarnos  
Altura máxima móvil

IT

Reazioni in servizio  
Reazioni fuori servizio

A vuoto, senza zavorra (ne assali di trasporto) con braccio massimo e altezza massima.

Consultateci  
Altezza massima gru traslante

PT

Reações em serviço  
Reações fora de serviço

Sem carga (nem trem de transporte) - sem lastro com lança e altura máximas.

Consultar-nos  
Altura máxima sobre translação

RU

Реакции при работе  
Реакции в покое

Вес без груза, балласта (или транспортных осей), с максимальной длиной стрелы и максимальной высотой.

Проконсультируйтесь у нас  
Максимальная высота при движении крана по подкрановым путям

**Courbes de charges**  
**Lastkurven**  
**Load diagrams**  
**Curvas de cargas**  
**Curve di carico**  
**Curva de cargas**  
**Диаграммы грузоподъемностей**

MDV 2

65 m	3,1	▶	12,1	15	17	20	21,5	23,1	25	27	30	32	35	37	40	42	45	47	50	52	55	57	60	62	65	m
▲▲▲			10	7,7	6,7	5,5	5↔5	4,6	4,2	3,7	3,4	3	2,85	2,6	2,45	2,25	2,1	1,95	1,85	1,7	1,65	1,5	1,45	1,35	t	
60 m	3,1	▶		15,2	17	20	22	25	27,3	29,3	32	35	37	40	42	45	47	50	52	55	57	60				m
▲▲▲			10	8,8	7,3	6,5	5,6	5↔5	4,5	4,1	3,8	3,5	3,3	3	2,85	2,65	2,5	2,35	2,25	2,1					t	
55 m	3,1	▶		17,6	20	22	25	27	30	31,8	33,9	35	37	40	42	45	47	50	52	55						m
▲▲▲			10	8,6	7,7	6,7	6,1	5,4	5↔5	4,8	4,5	4,1	3,9	3,6	3,4	3,2	3	2,85							t	
50 m	3,1	▶		19,2	20	22	25	27	30	32	34,7	37,1	40	42	45	47	50									m
▲▲▲			10	9,5	8,6	7,4	6,7	6	5,5	5↔5	4,6	4,3	4	3,8	3,55										t	
45 m	3,1	▶		19,9	22	25	27	30	32	35	36,1	38,6	40	42	45											m
▲▲▲			10	8,9	7,7	7,1	6,2	5,8	5,2	5↔5	4,8	4,5	4,2												t	
40 m	3,1	▶		20,3	22	25	27	30	32	35	36,8	39,3	40													m
▲▲▲			10	9,1	7,9	7,2	6,4	5,9	5,3	5↔5	4,9														t	
35 m	3,1	▶		20,6	22	25	27	30	32	35																m
▲▲▲			10	9,3	8	7,3	6,5	6	5,4																t	
30 m	3,1	▶		20,6	22	25	27	30																		m
▲▲▲			10	9,3	8	7,3	6,5																		t	
25 m	3,1	▶		20,8	22	25																				m
▲▲▲			10	9,4	8,1																				t	

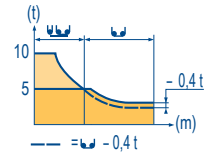

65 m	3,1	▶	12,5	15	17	20	22,5	22,9	25	27	30	32	35	37	40	42	45	47	50	52	55	57	60	62	65	m
▲▲▲			10	8,1	7	5,8	5↔5	4,5	4,1	3,6	3,3	2,95	2,75	2,45	2,3	2,1	2	1,8	1,7	1,55	1,5	1,35	1,3	1,2	t	
60 m	3,1	▶		15,7	17	20	22	25	28,3	28,8	30	32	35	37	40	42	45	47	50	52	55	57	60			m
▲▲▲			10	9,1	7,5	6,7	5,8	5↔5	4,8	4,4	4	3,7	3,4	3,2	2,9	2,7	2,5	2,4	2,2	2,1	1,95				t	
55 m	3,1	▶		17,9	20	22	25	27	30	32,5	33,2	35	37	40	42	45	47	50	52	55						m
▲▲▲			10	8,8	7,9	6,8	6,2	5,5	5↔5	4,7	4,4	4	3,8	3,5	3,3	3	2,9	2,7							t	
50 m	3,1	▶		19,5	20	22	25	27	30	32	35,5	36,2	40	42	45	47	50									m
▲▲▲			10	9,7	8,7	7,5	6,9	6,1	5,7	5↔5	4,4	4,2	3,9	3,7	3,4										t	
45 m	3,1	▶		20,2	22	25	27	30	32	35	36,9	37,7	40	42	45											m
▲▲▲			10	9,1	7,9	7,2	6,4	5,9	5,3	5↔5	4,7	4,4	4,05												t	
40 m	3,1	▶		20,6	22	25	27	30	32	35	37,5	38,3	40													m
▲▲▲			10	9,3	8	7,3	6,5	6	5,4	5↔5	4,75														t	
35 m	3,1	▶		20,8	22	25	27	30	32	35																m
▲▲▲			10	9,4	8,1	7,4	6,6	6,1	5,5																t	
30 m	3,1	▶		20,8	22	25	27	30																		m
▲▲▲			10	9,4	8,1	7,5	6,6																		t	
25 m	3,1	▶		21	22	25																				m
▲▲▲			10	9,5	8,2																				t	

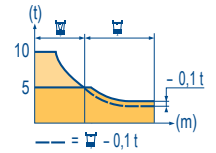

**Lest de contre-flèche**  
**Gegenauslegerballast**  
**Counter-jib ballast**  
**Lastre de contra flecha**  
**Contrappeso**  
**Lastros da contra lança**  
**Балласт на консоли**

MDV 2

	1 100 kg - 3 600 kg	
▲▲▲		(kg)
65 m		18 800
60 m		18 800
55 m	17,2 m	18 800
50 m		18 800
45 m		17 700
40 m		16 600
35 m	14,7 m	15 500
30 m		14 400
25 m		13 000

**Lest de base**  
**Grundballast**

**Base ballast**  
**Lastre de base**

**Zavorra di base**  
**Lastros da base**

**Базовый балласт**

MDV 2

☐ 1,6 m	S 41 A	•●•	H (m)	55,7	50,7	45,7	40,7	35,7	30,7	25,7	20,7	15,7
			▲ (t)	114	84	78	78	78	78	78	78	78
☐ 1,6 m	ZD 4230	•●•	H (m)	47,7	42,7	37,7	32,7	27,7	22,7	17,7		
			▲ (t)	80	80	80	80	80	80	80		
☐ 1,6 m	ZD 463	•●•	H (m)	53	48	43	38	33	28	23	18	
			▲ (t)	95	75	75	75	75	75	75	75	
☐ 2 m	V 60 A	•●•	H (m)	65,2	61,9	56,9	51,9	46,9	41,9	36,9	31,9	26,9
			▲ (t)	132	120	84	60	48	36	36	36	36
☐ 2 m	ZD 463	•●•	H (m)	51,3	49,6	48	43	38	33	28	23	18
			▲ (t)	105*	95	80	70	70	70	70	70	70











**City Topless**  
**MDT 218 J10**



<b>FR</b>	<b>DE</b>	<b>EN</b>	<b>ES</b>	<b>IT</b>	<b>PT</b>	<b>RU</b>
<b>A</b> Distance entre cadres	Abstand zwischen den Rahmen	Distance between collars	Distancia entra marcos	Distanza fra i telai	Distância entre quadros	Расстояние между рамками крепления
<b>H1</b> Hauteur grue	Kranhöhe	Crane height	Altura grúa	Altezza gru	Altura da grua	Высота крана
<b>P</b> Poids de la grue (en service)	Krangewicht (in Betrieb)	Crane weight (in service)	Peso de la grúa (en servicio)	Peso della gru (in servizio)	Peso da grua (em serviço)	Вес крана (при работе)
<b>R</b> Réaction horizontale	Horizontalkräfte	Horizontal reaction	Reaccion horizontal	Reazione orizzontale	Reacção horizontal	Горизонтальные реакции
<b>*</b> Voir télescopage sur dalles	Siehe Kletterkrane in Gebäude	See climbing crane	Veja grua trepadora	Consultare gru in caviedo	Ver telescopagem sobre lages	См. кран. ползущий внутри здания
<b>*</b> Utilisation poste fixe	Nur stationärer Einsatz	Only static use	Utilización chasis fijo	Solo in postazione fissa	Utilização sobre chassis fixo	Не использовать при перемещении крана по подкрановым путям





Mécanismes  
Antriebe  
Mechanisms  
Mecanismos  
Meccanismi  
Mecanismos  
Механизмы

MDV 2

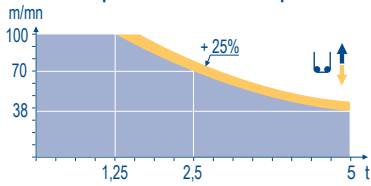
		U						U						ch - PS hp	kW														
	50 LVF 25 Optima	m/min	3	→	12	→	38	→	50	→	70	→	100	1,5	→	6	→	10	→	10	→	10	→	10	→	10	50	37	278 m
	t	5	5	5	3,75	2,5	1,25	10	10	10	7,5	5	2,5																
	50 LVF 25 GH Optima	m/min	3	→	12	→	38	→	50	→	70	→	100	1,5	→	6	→	10	→	10	→	10	→	10	→	10	50	37	515 m
	t	5	5	5	3,75	2,5	1,25	10	10	10	7,5	5	2,5																
	7 DVF 4	m/min	0 → 79												6,5	4,8													
	RVF 152 Optima +	tr/min U/min - rpm	0 → 0,8												2 x 5,5	2 x 4													
	ZD 4230 RT 324	m/min	12,5 - 25												2 x 7	2 x 5,2													
	ZD 463 RT 443 A1 2V	m/min	15 - 30												4 x 5	4 x 3,7													
	S 41 A RT 443 A1 2V R ≥ 10 m	m/min	15 - 30												4 x 5	4 x 3,7													
	V 60 A RT 544 A1 2V R ≥ 13 m	m/min	13,5 - 27												4 x 7	4 x 5,2													
CEI 38  IEC 38														kVA															
400 V (+6% -10%)														50 LVF : 65 kVA															

50 LVF 25 Optima - 50 LVF 25 GH Optima



	FR	DE	EN	ES	IT	PT	RU
	Levage	Heben	Hoisting	Elevación	Sollevamento	Elevação	Подъём
	Distribution	Katzfahren	Trolleying	Distribución	Distribuzione	Distribuição	Перемещение каретки
	Orientation	Schwenken	Slewing	Orientación	Rotazione	Rotação	Поворот
	Translation	Kranfahren	Travelling	Traslación	Traslazione	Translação	Перемещение крана

 Document commercial non contractuel. Pour toute information technique se référer à la notice correspondante. Unverbindliches Vertriebsdokument. Für technische Informationen, siehe die entsprechenden Anweisungen. This commercial document is not legally binding. For any technical information, please refer to the corresponding instructions. Documento comercial no contractual. Para cualquier información técnica, ver la noticia correspondiente. Documento commerciale non vincolante, per tutte le informazioni tecniche fare riferimento al catalogo istruzioni. Documento comercial não contractual. Para qualquer informação técnica complementar consultar as respectivas instruções. Этот коммерческий документ не является юридически обязательным. Для получения технической информации, см. соответствующие инструкции.



**Americas**  
Tel : +1 888 479 7278  
Tel : +1 717 593 2000

**Europe - Middle East - Africa**  
Tel : +33 (0) 4 72 81 50 00  
Tel : +44 (0) 191 522 2000

**Asia - Pacific**  
Tel : +65 6264 1188  
Fax : +65 6862 4040

www.manitowocranes.com

18, rue de Charbonnières - B.R.173  
69132 ECULLY Cedex - France  
Tél. : +33 (0) 4 72 18 20 20  
Fax. : +33 (0) 4 72 18 20 00  
www.manitowocranes.com

**City Topless MDT 218 J10**  
Réf. 2006 38 MDV 2

Copyright.Reproduction interdite © POTAIN 2006

Réalisation Secdoc